

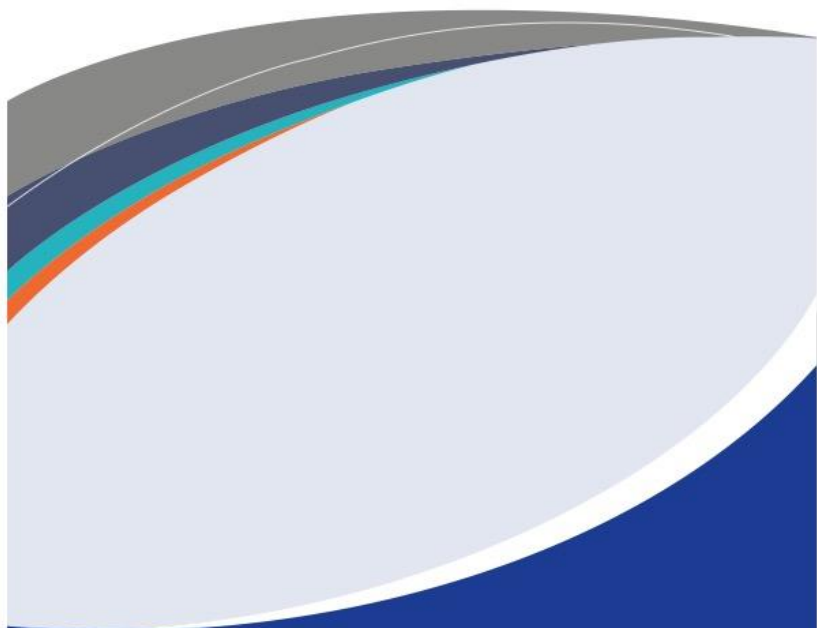

MedAir® *Comfort*

Powered Pressure Reducing Air Mattress

Product code: MA-COMFORT



Improving patient care and enhancing the quality of people's lives

Address: 450 Satellite Boulevard NE, Suite A&B
Suwanee, GA 30024 U.S.A
Tel: 1-888-5MEDWAY (563-3929)



INTRODUCTION

Congratulations on the purchase of your **MedAir® Comfort** Air Mattress. The durable, high-quality material used in the manufacturing of this product will ensure that you experience long-lasting and uninterrupted performance.

Intended Use

This product is intended to help reduce the incidence of pressure ulcers while optimizing patient comfort. It also provides the following purposes:

- To help and reduce the incidence of pressure ulcers while optimizing patient comfort.
- For long term home care of patients suffering from pressure ulcers.
- For pain management as prescribed by a physician.

The product can only be operated by personnel who are qualified to perform general nursing procedures and have received adequate training in knowledge of prevention and treatment of pressure ulcers.

Contraindication

Patient conditions for which the application of pressure relieving therapy on an alternation system is contraindicated are as follows:

- Cervical or skeletal traction
- Unstable spinal cord injuries

Name: MedWay Group

Address: 450 Satellite Blvd. NE Suite A & B Suwanee, GA 30024

Phone: 1.888.563.3929







Email: sales@medwayus.com











Web: www.medwayus.com

Table of Contents

Table of Contents	3
Symbol definition	4
Products Feature	6
Safety Precautions.....	7
Confirm before set-up	11
Parts Name	12
Set-Up instructions.....	13
Maintenance.....	16
Storage.....	17
Troubleshooting	19
Warranty and after-sales service	20
(Please read carefully)	20
Specification list	22
EMC Declaration	22
EMC information	22

Symbol definition

	CE certification and notified body number
	Product production batch
	Product serial number
	Manufacturer information
	II type equipment symbol
	Mandatory reading of instructions
	BF device symbol
IP21	Protected against solid foreign objects of 12.5mm and greater; protection against vertically falling water drops.

	<p>When the end user intends to discard this product, the product must be sent to the appropriate facility for recycling and recycling.</p>
	<p>Environment humidity for operation or storage</p>
	<p>Environment temperature for operation or storage</p>
	<p>Atmospheric pressure for operation or storage</p>
	<p>Maximum weight of the mattress load.</p>
	<p>Do not wash the mattress.</p>
	<p>Do not bleach the mattress.</p>
	<p>Do not tumble dry.</p>
	<p>Do not iron.</p>
	<p>Do not dry clean.</p>

Product Features

1. Two-channel alternating mode

The **MedAir® Comfort** mattress will alternate about every 6 minutes; This action supports the body while inflating and relaxes the body while deflating. This action is intended to reduce stress on the patient.

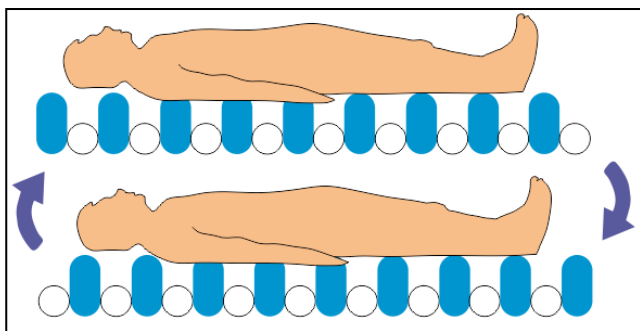

2. Tube structure

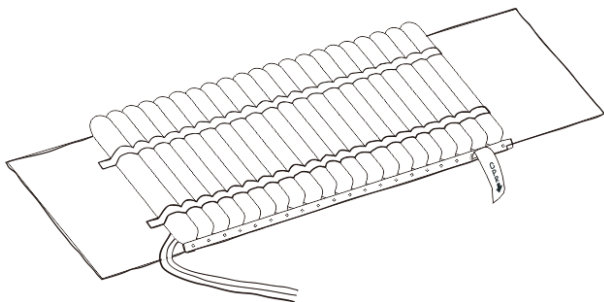

Safety Precautions

In order to use this product safely, please read this book carefully and understand it, please be sure to follow the instructions in this manual. In order to avoid injury when using this product, you must know in advance the factors that may be dangerous. However, it is difficult to predict all potential dangers. Therefore, warnings about proper use are defined and described in this manual.



Warning

When this symbol is indicated please follow the instructions carefully. This symbol indicates that there is a risk of property damage, injury or death. Because it is especially important, it is described below as "safety precautions and warnings"

Safety warning



Warning 1

This product features a layer of soft air floating beneath the patient's body. Therefore, do not use when patients need to undergo cardiac resuscitation. When using emergency measures such as CPR, use it under the guidance of a doctor.



Warning 2

Use this product with your doctor or specialist when using this product. In addition, if the body feels abnormal during use, or the symptoms are worse, or there is a risk of accident, stop using it immediately and consult your doctor or health care provider.



Warning 3

When installing the mattress, place the airway tube feed at the FOOT END OF BED.

DO NOT place tube feed in any other position as patient injury may occur.

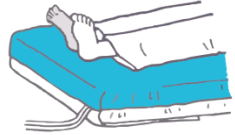

Warning 4

When using the mattress, be sure to secure the guardrail to the bed. Failure to use the guardrail may result in a fall from the bed, which may result in an injury.

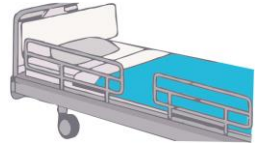

Warning 5

Please do not jump on the mattress, it may cause injury or damage. Do not stand on the air mattress or kneel on the mattress. There is a risk of damaging the airbag when high pressure is applied locally.



Warning 6

When you move to a sitting position or get out of bed, be sure to ask someone else for assistance, otherwise there is a danger of falling.



Warning 7

Smoking is not allowed on the mattress and may cause a fire.



Warning 8

Please be aware not to bend or kink the air tube. Do not place tube under mattress. If tube is damaged or kinked air flow will not inflate the mattress



Warning 9

Please do not use two or more people together. This may result in mattress inflation failure and cause damage to the mattress.



Warning 10

DO NOT use the air pump in a damp place. Do not expose the pump to liquid. Doing so may result in electric shock or malfunction. Avoid direct sunlight. In hot and humid places, keep it away from the wall or above 55cm to avoid moisture retention.



Warning 11

DO NOT attempt to repair air pump; contact MedWay Group for authorized service center. Opening the pump unit may cause electric shock or malfunction. In addition, the modification of the air pump may pose a serious safety hazard.



Warning 12

Be sure to plug the air pump's power plug into a standard wall power outlet (120v). DO NOT insert or unplug the power plug with wet hands as this may result in electric shock.



Warning 13

If the mattress and air pump will not be used for a long time or the air pump needs to be cleaned, unplug the power cord from the outlet. Failure to do so may cause accidents, electric shocks, and malfunctions.



Warning 14

Please do not pull on the power cord of the air pump, do not damage the power cord, and do not clip the power cord to the door. When removing the plug from the socket, be sure to hold the power plug and pull it out to avoid damage to the power cord.



Warning 15

DO NOT use mattress without a sheet between patient and mattress. Skin should not directly contact the air mattress as to prevent the body fluid from contaminating the air mattress.

Confirm before set-up

Before set-up, please confirm whether the accessories are complete and whether you understand the contents and precautions of the manual.

Packing list confirmation

- ① Air pump for air mattress.....x 1
- ② User Manual.....x 1
- ③ Air mattress (Ball type or Tube type).....x 1

1



2

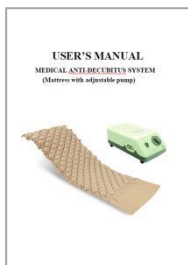

3

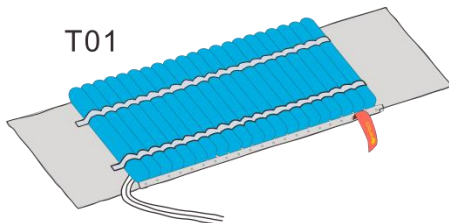

Parts Name

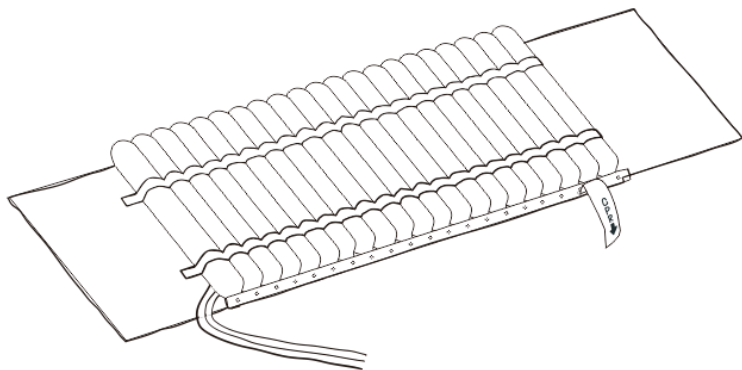

Set-Up instructions

Step1:

Remove and unfold the **MedAir® Comfort** Air Mattress from box. Place the air mattress on existing bed mattress with the air tube positioned at the foot end of the bed, right hand side. Secure to bed mattress by folding the extra material under the bed mattress. This should be done at the top and bottom of the air mattress.

NOTE: BE CAREFUL not to kink or bend the air tube when securing the air mattress to the bed mattress. See figure 1

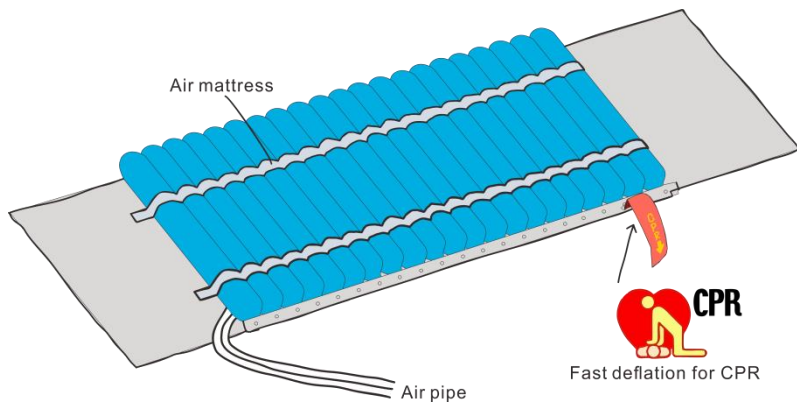

Step2:

With the enclosed hangers. Hang the pump to the foot side of bed.

Connect the air tube to the pump. See figure 2



Step3:

Make sure the red CPR valve (top right side of air mattress) is securely closed.

Connect the Air Supply Hose from the air mattress securely to the pump. Place sheet over mattress and fold under to secure. See figure 3

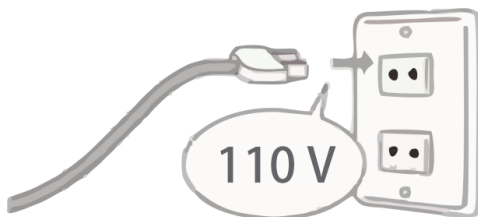

Step4:

Plug the Electrical Supply Cable from the pump into a standard electrical outlet and turn the green power switch to the on position. Adjust the air pressure to desired firmness. See figure 4. **Please**

NOTE: The air mattress will start to inflate and be ready for use in approximately 12 mins.



Step5:

- Adjust pressure based on patient's comfort by turning pressure dial
- Air pump output pressure table:

Min	1	2	3	4	5(max)
20mmHg	30mmHg	50mmHg	70mmHg	100mmHg	120-140mmHg



Warning

- Since the mattress is alternated every 6 minutes, it takes about 12 minutes for the pressure to reach the set value when a new pressure is set.
- The pressure value of the mattress is about half of the set value of the air pump.
- The higher the severity of pressure sores, the lower the pressure should be set, it is best to follow doctor's advice.

Maintenance

Warning: DO NOT open the pump for maintenance. If pump is not working contact MedWay Group for service.

Mattress cleaning

- To clean mattress use a damp cloth with a neutral detergent.
- Let it dry naturally



Warning

- DO NOT Dry Clean: doing so will damage the mattress
- DO NOT use a clothes dryer or any other type of dryer, doing so will cause deformation of the mattress.
- DO NOT use an iron to avoid damage to the mattress

Air pump cleaning

- Turn off the power switch and unplug the power cord
- Use a dry rag to clean the air pump

Warning: If it is not used for a long time, be sure to unplug the power cord to avoid possible injury from tripping or entanglement.

Storage

If you are no longer using this product, please follow the steps below to store.

- 1. Turn off the power switch and unplug the power cord.
- 2. Unplug the air tube
- 3. Clean air pump and mattress (see previous instructions for cleaning)
- 4. Fold the mattress and put it in a plastic bag or container.
- 5. Wrap the power cord and put the air pump in a plastic bag or container.
- 6. Put the air pump and mattress in a box, together with this manual



Warning

- Please put it in a stable place, safe from dropping.
- DO NOT put heavy objects on the storage box.
- Please keep it in a place with low humidity.

Environmental Specifications

For transport and storage:

Ambient temperature: -20°C- +55°C

Relative humidity: 10% - 90%RH, but not requiring a water vapor partial pressure greater than 50hPa

Atmospheric pressure: 80KPa to 106KPa

For operation:

Ambient temperature: +5°C - +35°C

Relative humidity: 15% - 85%

Atmospheric pressure: 86KPa to 106KPa



Warning

- When the equipment storage temperature is minimum or maximum, You should warm or cool the temperature for 1 hour to operate temperature for use.

Troubleshooting

Trouble	Possible reason
Does not start, power light indicator not lit.	The power plug is not plugged into the power outlet. The power supply does not work. Contact MedWay Group for service.
Air mattress is too soft	Valve does not work. Contact MedWay Group for service. Air duct off. Check and reconnect. Air duct bend. Check and unbend. Adjustment knob error. Check setting. Damaged mattress. Contact MedWay Group for service.
Air mattress is too soft	Adjustment knob error. Check setting.
Air pump noise is abnormally loud.	Possible pump vibration. Put something on the air pump to weigh down. The air pump is in contact with other things. Move pump to different location at end of bed. Put the air pump on something that moves with the pump vibration.
Power outage	Check electrical power of room.

Warranty and after-sales service

(Please read carefully)

Service life and Shelf life

- EXPECTED SERVICE LIFE OF the pump is 2 years
- EXPECTED SERVICE LIFE OF the mattress is 2 years
- Shelf life of the PVC mattress more than 10 years in the required environment.
- Shelf life of the TPU mattress is 2 years in the required environment, because TPU is an environmentally friendly material that will biodegrade after two years.

Warranty Period

Item	Warranty
PUMP	12 months, 15 months with registration
MATTRESS	12 months, 15 months with registration

About the repair request

First, look at the possible causes (see page 14). If you are still having trouble, turn off the product and contact MedWay Group. 1.888.563.3929.

During the warranty period:

- In the event of a malfunction in a normal use condition, MedWay Group. Will repair according to the provisions of the warranty.
- Please provide your warranty information when requesting service.

After the warranty expires:

- Please consult with MedWay Group or company you purchased, and if the product is repairable, please ask for repair cost estimate.



Warning

ALL SERVICE TO AIR PUMP AND MATTRESS MUST BE COMPLETED BY AN AUTHORIZED MEDWAY GROUP SERVICE PERSON. DO NOT ATTEMPT TO REPAIR OR REPLACE ANY PARTS OF THE AIR PUMP OR MATTRESS. PERSONAL INJURY MAY OCCUR TO PERSON ATTEMPTING REPAIR OR TO PATIENT USING THE PRODUCT. CONTACT MEDWAY GROUP @ 888.563.3929 FOR SERVICE.

Specifications

Mattress Dimensions: W36xL78xH4.5" Weight: 11.69Lbs Material: Nylon PVC coated cloth

Pump Dimensions: L8.66xW4.33xH3.27" Weight: 1.98Lbs Material: ABS plastic

Power: 110Vac 60Hz 12VA Power cord length: 6.6 Ft

Fuse: Time-lag type 500mA 250V Size 0.14x0.39"

EMC Declaration

Guidance and manufacturer's declaration-electromagnetic emissions

The device is intended for use in the electromagnetic environment specified below. The customer or the user of the device should assure that they are used in such an environment.

Emissions test	Compliance	Electromagnetic environment - guidance
RF emissions CISPR 11	Group 1	The models device use RF energy only for their internal function. Therefore, their RF emissions are very low and are not likely to cause any interference in nearby electronic equipment.
RF emissions CISPR11	Class B	The models P01, P05 are suitable for used in domestic establishment and in establishment directly connected to a low voltage power supply network which supplies buildings used for domestic purposes.
Harmonic emissions IEC 61000-3-2	Class A	
Voltage fluctuations / Flicker emissions IEC 61000-3-3	Complies	

Warning:

1. The device should not be used adjacent to or stacked with other equipment. If adjacent or stacked use is necessary, the device should be observed to verify normal operation in the configuration in which it will be used.
2. Use of accessories, transducers and cables other than those specified or provided by the manufacturer of this equipment could result in increased electromagnetic emissions or decreased electromagnetic immunity of this equipment and result in improper operation.
3. Portable RF communications equipment (including peripherals such as antenna cables and external antennas) should be used no closer than 30 cm (12 inches) to any part of the Pump, including cables specified by the manufacturer. Otherwise, degradation of the performance of this equipment could result.

Guidance and Declaration-electromagnetic immunity			
The models device intended for use in the electromagnetic environment specified below. The customer or the user of the device should assure that they are used in such an environment.			
Immunity test	IEC 60601 test level	Compliance level	Electromagnetic environment -guidance
Electrostatic discharge (ESD) IEC 61000-4-2	±8 kV contact ±2 kV, ±4 kV, ±8 kV, ±15 kV air	±8 kV contact ±2 kV, ±4 kV, ±8 kV, ±15 kV air	Floors should be wood, concrete or ceramic tile. If floors are covered with synthetic material, the relative humidity should be at least 30 %.
Electrical fast transient/burst IEC 61000-4-4	±2kV for power supply lines ±1 kV for Input/output lines	±2kV for power supply lines	Mains power quality should be that of a typical commercial or hospital environment.
Voltage dips, short interruptions and voltage variations on power supply input lines IEC 61000-4-11.	<5 % UT (>95% dip in UT.) for 0.5 cycle <5 % UT (>95% dip in UT) for 1 cycle 70% UT (30% dip in UT) for 25/30 cycles <5% UT (>95 % dip in UT) for 5/6 sec	<5 % UT (>95% dip in UT.) for 0.5 cycle <5 % UT (>95% dip in UT) for 1 cycle 70% UT (30% dip in UT) for 25/30 cycles <5% UT (>95 % dip in UT) for 5/6 sec	Mains power quality should be that of a typical commercial or hospital environment. If the user of the models P01, P05 require continued operation during power mains interruptions, it is recommended that the models P01, P05 powered from an uninterruptible power supply or a battery.
Power frequency (50/60 Hz) magnetic field IEC 61000-4-8	30 A/m	30 A/m	Power frequency magnetic fields should be at levels characteristic of a typical location in a typical commercial or hospital environment.
NOTE UT is the a.c. mains voltage prior to application of the test level.			
Conducted RF IEC 61000-4-6	3 Vrms 150 kHz to 80 MHz 6 Vrms in ISM and amateur radio bands	3 Vrms 150 kHz to 80 MHz 6 Vrms in ISM and amateur radio bands	Portable and mobile RF communications equipment should be used no closer to any part of the models P01, P05 including cables, than the recommended separation distance calculated from the

<p>Radiated RF IEC 61000-4-3</p>	<p>10 V/m 80 MHz to 2.7 GHz.</p> <p>385MHz- 5785MHz Test specifications for ENCLOSURE PORT IMMUNITY to RF wireless communication equipment (Refer to table 9 of IEC 60601- 1-2:2014)</p>	<p>10 V/m 80 MHz to 2.7 GHz</p> <p>385MHz- 5785MHz Test specifications for ENCLOSURE PORT IMMUNITY to RF wireless communication equipment (Refer to table 9 of IEC 60601-1-2:2014)</p>	<p>equation applicable to the frequency of the transmitter.</p> <p>Recommended separation distance $d=[3.5/\sqrt{P}] \times P^{1/2}$</p> <p>$d=1.2 \times P^{1/2}$ 80 MHz to 800 MHz $d=2.3 \times P^{1/2}$ 800 MHz to 2.7 GHz</p> <p>where P is the maximum output power rating of the transmitter in watts (W) according to the transmitter manufacturer and d is the recommended separation distance in meters (m).</p> <p>Field strengths from fixed RF transmitters, as determined by an electromagnetic site survey, a should be less than the compliance level in each frequency range. b Interference may occur In the vicinity of equipment marked with the following symbol:</p> 
<p>NOTE 1 At 80 MHz and 800 MHz. the higher frequency range applies.</p> <p>NOTE 2 These guidelines may not apply in all situations. Electromagnetic propagation is affected by absorption and reflection from structures, objects and people.</p>			
<p>a Field strength from fixed transmitters, such as base stations for radio (cellular/cordless) telephones and land mobile radios, amateur radio, AM and FM radio broadcast and TV broadcast cannot be predicted theoretically with accuracy. To assess the electromagnetic environment due to fixed RF transmitters, an electromagnetic site survey should be considered. If the measured field strength in the location in which the models P01, P05 are used exceeds the applicable RF compliance level above, the models P01, P05 should be observed to verify normal operation. If abnormal performance is observed, additional measures may be necessary, such as reorienting or relocating the models P01, P05.</p> <p>b Over the frequency range 150 kHz to 80 MHz, field strengths should be less than 3V/m.</p>			

Recommended separation distances between portable and mobile RF communications equipment and the models P01, P05

The models P01, P05 are intended for use in electromagnetic environment in which radiated RF disturbances are controlled. The customer or the user of the models P01, P05 can help prevent electromagnetic interference by maintaining a minimum distance between portable and mobile RF communications equipment (transmitters) and the models P01, P05 are recommended below, according to the maximum output power of the communications equipment.

Rated maximum output Power of transmitter W	Separation distance according to frequency of transmitter m		
	150kHz to 80MHz $d=1.2 \times P^{1/2}$	80MHz to 800MHz $d=1.2 \times P^{1/2}$	800MHz to 2,5GHz $d=2.3 \times P^{1/2}$
0.01	0.12	0.12	0.23
0.1	0.38	0.38	0.73
1	1.2	1.2	2.3
10	3.8	3.8	7.3
100	12	12	23

For transmitters rated at a maximum output power not listed above, the recommended separation distance d in meters (m) can be estimated using the equation applicable to the frequency of the transmitter, where P is the maximum output power rating of the transmitter in watts (W) accordable to the transmitter manufacturer. NOTE 1 At 80 MHz and 800 MHz. the separation distance for the higher frequency range applies.

NOTE 2 These guidelines may not apply in all situations. Electromagnetic propagation is affected by absorption and reflection from structures, objects and people.



Warranty Card

This warranty guarantees that the product will be freely warranted in accordance with the contents of this book in the event that the product is used in accordance with the instructions during the warranty period.

When the failure occurs during the warranty period, please bring the product and this warranty to the distributor for repair. Please fill in the necessary information in the # column, otherwise it will be invalid.

Each product is only accompanied by a guarantee, please keep it in a safe place.

1. Please allow me to use this book as a warranty for air pumps and mattresses.
2. If the damage is caused by the following reasons during the warranty period, the repair is subject to a charge.
 - Failure due to improper operation and handling.
 - Modify the device privately.
 - Abnormalities caused by fire, earthquake, lightning, and other natural disasters.
 - There is no serial number on the main body of the air pump or it cannot be confirmed.
3. If you are unable to provide distributor information, please discuss with the company.

Free warranty period (from the date of purchase)		Day	Month	Year
#Customer Information				
Name:		Tel:		
Address:				
#Distributor				
Distributor Name / Address / Tel				

CHANGE HISTORY		
Version	Description	Date
1.0	Fist release version	2019-06
1.1	European Representative and Manufacturer Address description	2020-05

US DISTRIBUTOR: MEDWAY GROUP

Phone: 1.888.563.3929

E-mail: sales@medwayus.com

F-Website: www.medwayus.com